



Weller[®]

Fume Extraction Solutions

We care for your working environment.

**COOPER** Tools



Content

Why Fume Extraction?	3
Zero-Smog® System	3
Tip Extraction and Volume Extraction	4
Filter Technology	5
Filter Process	5
Volume Extraction	6 – 17
WFE 8S	8
WFE 4S	9
WFE 2X	10
WFE 2S	11
WFE 2ES / WFE 2CS	12
Installation Options	13
Accessories	14 – 17
Replacement Filters	17
Tip Extraction	18 – 26
WFE	20
WFE P	20
WFE 20D	21
FE (Fume Extraction) Soldering Irons	22 – 23
Safety Rests	23 – 24
Accessories	25
Replacement Filters	25
Installation Options	26
Pipe Systems for Tip and Volume Extraction	27



Why Fume Extraction?

Work activities such as soldering, adhesives dispensing, welding, and laser operations create particles and gases that can be harmful to workers and the environment. This is especially true for lead-free soldering applications, due to the high working temperatures required and because more flux is used compared to lead soldering. These factors combine to cause substantial amounts of smoke containing high levels of breathable fine dust particles. Fine particles are more dangerous to inhale than big particles, as they get caught more easily in the alveoli in the lungs, resulting in breathing difficulties and other more serious health issues.

Many companies are now realizing that it is important to reduce worker exposure to the breathable fine dust particles and hazardous vapors found in certain work environments. The most cost-effective way to accomplish this is to put in place an extraction system that is able to separate these particles and gases and then re-circulate the cleaned air back into the work place. This saves energy and reduces energy costs. Additionally, many countries have already instituted regulations governing air quality in the work place. These regulations stipulate that hazardous substances must be removed from the air in order to avoid harmful effects on workers.

Weller® Zero-Smog® Systems

It is extremely important to choose the correct equipment when attempting to control workplace air quality. Weller can give you expert advice and provide the perfect system solution for your unique application. Zero-Smog Systems from Weller protect workers and the environment with sophisticated filters that catch the polluted air right at the source, preventing the diffusion of particles and gases. A broad range of filters can be combined to provide the best solution to specific filtering requirements. Weller has filters suitable for all common applications found in industry and laboratories,

including lead-free soldering, adhesives dispensing, laser operations, and many more.

Zero-Smog® Systems help to create a highly productive work environment. Their small size and quiet operation makes them easy to place and unobtrusive. Extraction arms and nozzles are fully adjustable so they can get close to the source for optimum fume capture. To increase filter lifetime and save energy, most Zero-Smog Systems are fitted with an automatic speed control. Integrated pre-filters are also available to further extend filter life and boost filtering efficiency.



Weller® Zero-Smog® Systems offer two solutions for fume extraction:

Tip Extraction



Volume Extraction

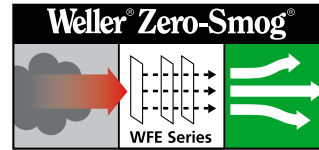

Tip Extraction

Suitable for applications involving a small working area, such as hand soldering. Weller FE (Fume Extraction) soldering irons have a smoke tube integrated into the handle. The tube is positioned directly above the joint and collects any fumes produced. Fume extraction attachments can also be retro-fitted to non-fume extraction Weller soldering irons.

- Lower cost per workstation
- Collects pollution directly at source
- Up to 20 collection points per system (Up to 200 m apart)
- Unobtrusive; provides easy access to work piece
- Silent operation
- Minimal air movement

Volume Extraction

Suitable for applications involving a wide working area, such as solder baths, hot air soldering, micro solders, and gluing. Weller offers various mobile systems that purify the air at up to eight workstations.

- Larger areas can be covered
- Low maintenance
- Mobile
- Quick & easy installation
- Economical for between one and eight workstations
- Remote control

Filter Technology

Weller® Zero-Smog® Systems are specifically designed for continuous operation in industrial environments. Care and attention at the design stage plus careful component choice and a high quality manufacturing process have given Weller fume extraction systems a worldwide reputation for reliability and longevity.

Weller Zero-Smog Systems have a **three stage filter system** for removing small particles, fumes, and gases that are produced in different working processes:

1. The hazardous substances are efficiently captured by the nozzle and are absorbed into the filter.
2. Bigger particles get caught in the pre-filter and smaller particles get caught in the HEPA (High Efficiency Particulate Air) filter.
3. The Wide Band Gas Filter removes fumes and adhesives.

End product – clean air – is re-circulated into the workplace.

Filter Class	Recommended Application
F 5	for standard applications
F 7	for applications with high flux content
H12 / H13	filter for clean rooms 1000 – 100

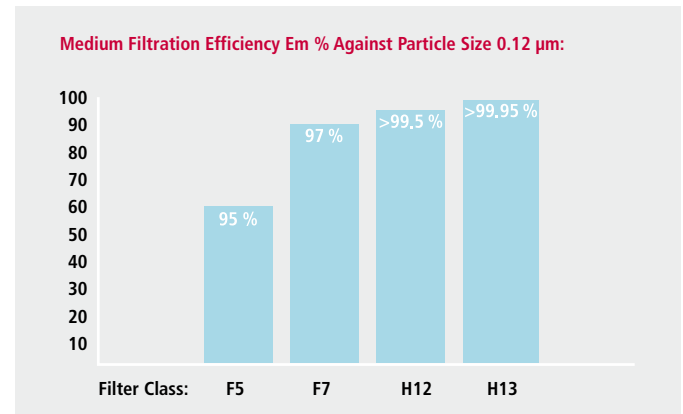
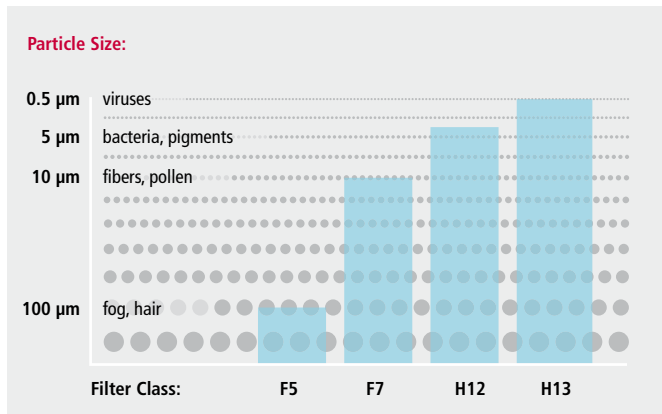

Filter Class F5, F7: Fine dust filter as per EN 779

Filter Class H12/H13: According EN 1822 HEPA (High Efficiency Particulate Air) Filter

Filter Process

WFE, WFE P

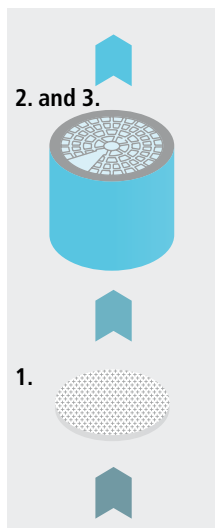

WFE 2X

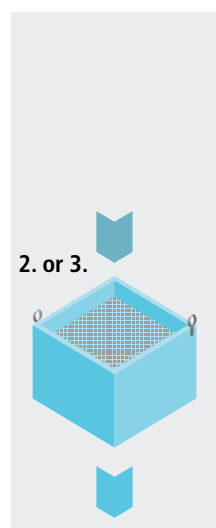

WFE 20D, WFE 2S,
WFE 4S, WFE 8S,
WFE 2ES, WFE 2CS

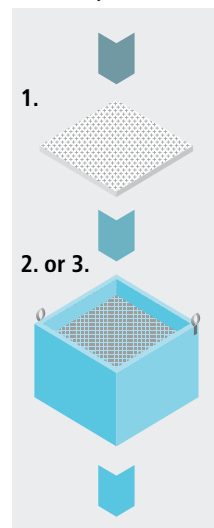

1. Fine dust filter

For standard applications with a small amount of flux and pollution gases with high solid content, Weller offers filter classes **F5** or **F7**.

2. Compact filter consisting of: HEPA filter

Filters particles up to 0.3 µm. Weller offers HEPA (High Efficiency Particulate Air) filters in classes **H12** and **H13** (medium filtration efficiency 99.5% / 99.95%).

Wide band gas filter

For cleaning harmful fumes and vapors. The Weller wide band gas filter consists of **50% active carbon** and **50% Puratex**. Harmful gases with a high molecular weight are cleaned by the active carbon. Puratex is suitable for absorbing gases of lower molecular weight. Because of its composition, Puratex is able to convert a large number of chemical pollutants into non-polluting gases by means of molecular modification.

3. Gas filter (optional)

The gas filter is used for extracting adhesive fumes and solvents. Experience has shown that filtering suspended particles is not so vital in this respect. The gas filter is filled with **50% active carbon** and **50% Puratex**. The HEPA H12 and H13 is omitted.

Volume Extraction

Volume Extraction

Volume extraction is the best choice where extraction over a wide area is required. It is an economical way to eliminate polluted process air as there is no need for fixed installations and maintenance requirements are minimal. Arms and nozzles do not require daily cleaning. Energy costs are saved because the cleaned air is re-circulated back into the work area and does not need to be heated or cooled like external air.

Weller has a broad range of filter units for volume extraction applications. Speed control allows optimal air flow regulation for each workstation independent of the number of connected workstations. Units can be remotely controlled via a remote control system (available as an accessory) or by a PC (via an RS232 connection).



Volume Extraction Units



- WFE 8S
 - Up to eight workstations,
 - Small solder ovens; selective and reflow soldering equipment
 - Integrated pre-filter



- WFE 4S
 - Up to eight workstations



- WFE 2X
 - Up to two workstations



- WFE 2S
 - Up to four workstations



- WFE 2ES / WFE 2CS
 - Up to two workstations

Characteristics

- For applications where extraction over a wide working area is required.
- Mobile units suitable for stand alone and central applications.
- All units equipped with maintenance-free brushless turbine.
- Connectable to external air outlet.
- Low vacuum (up to 2,800 Pa) and high volume for efficient volume extraction.
- Maximum bridging distance 30 m (WFE 4S using Weller Pipe System 75 -see page 27) equally distributed to all connected exhausts.
- Cost savings through automatic air flow control which provides each workstation with intelligent air flow regulation regardless of the connected workstations.
- Filter condition monitoring on the unit or by remote control (accessory).
- Wide range of extraction arms and nozzles available to achieve optimal workstation configuration.

Areas of application

- Hot air soldering
- Soldering machines, robots, solder baths
- Laser processing
- Adhesive dispensing
- Clean room applications (on request)
- Microscope workstations
- Other fume emitting processes



Volume Extraction

WFE 8S

Powerful fume extraction unit
with large integrated pre-filter



The WFE 8S fume extraction unit can be connected to up to eight extraction arms. This makes the unit suitable to use as a small central system in applications such as soldering, adhesives, clean-room work, and laser work. It is also capable for connection to small, selective reflow and soldering ovens. The large integrated pre-filter makes the WFE 8S very suitable for lead-free soldering as it is able to catch a large quantity of particles. The WFE 8S is a mobile system that is simple to install – it does not require any permanent installation.

Its high quality components keep service needs to a minimum. The combination of low running costs and a flexible system independent of fixed installations produces a unit with a very low cost of ownership.

The WFE 8S can be connected so that it exhausts air. This is an advantage in applications where re-circulation is not allowed. To further increase the filter lifetime and save energy, the WFE 8S has an automatic airflow control – depending on the number of connected workstations.

Attributes

- Mobile fume extraction unit purifies air at up to eight workstations
- Large built-in pre-filter
- The adjustable pressure control guarantees optimal air flow regulation for each workstation – independent of the number of connected workstations
- Electronic filter control and easy filter exchange
- Four wheels to allow easy movement of the unit
- Noise-dampened metal housing
- Quick and simple installation

Technical Data

Maximum capacity	8 workstations; small and medium sized reflow, wafer, and other selected equipment
Maximum extraction rate	615 m ³ /h
Sound level	< 55 db (A) at 1 m distance
Operating voltage	230/120 V / 50/60 Hz
Power input	450 VA
Maximum vacuum	2.800 Pa
Dimensions (L x W x H)	402 x 796 x 1016 mm 15.9 x 31.3 x 40 in.
Weight	68 kg / 150 lb.

WFE 8S includes:

- WFE 8S Fume Extraction Unit 230/120 V / 50/60 Hz with built-in pre-filter
- Compact filter
Consists of: HEPA filter H13, wide band gas filter (50% active carbon, 50% Puratex)

Order No. 230V	005 36 586 99
Order No. 120V	WFE8S

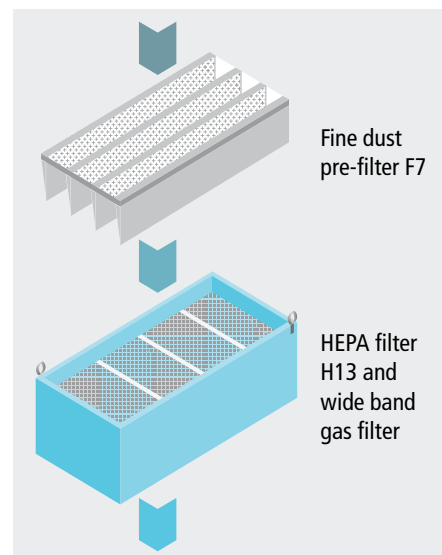

WFE 4S

Mobile fume extraction unit purifies air at up to eight soldering workstations



Attributes

- Mobile fume extraction unit purifies air at up to eight workstations
- The adjustable pressure control guarantees optimal air flow regulation for each workstation independent of the number of connected workstations
- Electronic filter control and easy filter exchange
- Four wheels to allow easy movement of the unit
- Remote control with alarm function
- Noise-dampened metal housing
- Quick and simple installation



ESD safe



low sound level

The WFE 4S fume extraction system is user-friendly with quick and simple installation and filter exchange. It has a low noise emission level and is small and convenient to locate within the work area.

The high quality components used in the WFE 4S result in low servicing requirements and long system life. To increase filter lifetime and save on energy, the WFE 4S is fitted with an automatic airflow speed control – depending on the number of connected workstations. To extend the capacity an external pre-filter can be fixed directly to the WFE 4S.

The powerful maintenance-free variable speed turbine is electronically controlled and has a maximum capacity of 615 m³/h. It has 3 operating modes:

1. Standard speed control – selected by the user irrespective of the load on the system.
2. Speed limiting control – the pump speed is automatically varied to match the load on the system.
3. Economy control – the rate of fume absorption is maintained at a constant value. The operating hours and the filter condition are recorded for maintenance purposes.

WFE 4S includes:

- WFE 4S Fume Extraction Unit 230/120 V / 50/60 Hz
- Compact filter
Consists of: HEPA filter H13 and wide band gas filter (50% active carbon, 50% Puratex)
- Fine dust pre-filter F7

Order No. 230V 005 36 256 99

Order No. 120V WFE4S

Pre-filter to extend capacity of WFE 2S, WFE 4S, WFE 2X



The pre-filter is recommended for use with solder bath, automatic soldering, laser, or other major dust-emitting applications. It acts as a first stage in the filter process, increasing the lifetime of the main filter units. The pre-filter can be fixed directly to the top of the WFE 4S or in conjunction with the WFE 2S and WFE 2X as an external part of the fume extraction system.

Pre-filter includes:

- Filter box
 - (2) hose connections 75
- Filters must be ordered separately (see pg. 17)

Order No.

005 87 358 62

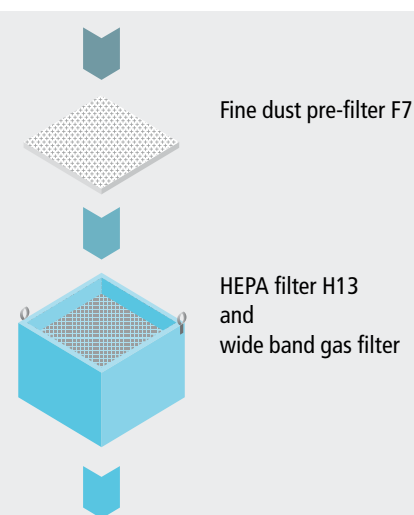

Fine dust pre-filter F7

HEPA filter H13 and wide band gas filter

Technical Data	
Maximum capacity	8 workstations
Maximum extraction rate	615 m³/h
Sound level	51 db (A) at 1 m distance
Standard connection	pipe system 75
Operating voltage	230/120 V / 50/60 Hz
Power input	450 VA
Maximum vacuum	2.800 Pa
Dimensions (L x W x H)	450 x 450 x 650 mm 17.7 x 17.7 x 25.6 in.
Weight	21 kg / 46.3 lb.

Option: WFE 4S with gas filter

- Compact filter for adhesive fumes; consists of wide band gas filter (50% active carbon, 50% Puratex)
- Fine dust filter F7

Order No. 230V 005 36 496 99

Order No. 120V WFE4SG

Volume Extraction

WFE 2X

Mobile fume extraction unit purifies air at up to two workstations



ESD safe



low sound level

The WFE 2X fume extraction unit is suitable for applications with a high demand for gas and particle filtration, e.g. soldering, adhesives, clean room work, and laser.

It can be placed on a trolley and moved easily between different workstations. Variable turbine speed and alarm function for filter exchange can be set via the remote control. For applications which produce a large quantity of particles, e.g. lead-free soldering, an external pre-filter can be fitted to increase the lifetime of the main filter. To make cleaning easier, the WFE 2X can be suspended under the work table with special fittings (optional accessory). An RS 232 interface makes it possible to integrate the software with other process equipment.

Technical Data

Maximum capacity	2 workstations
Maximum extraction rate	140 m³/h
Sound level	< 52 db (A) at 1 m distance
Operating voltage	100 – 240 V / 50/60 Hz
Power input	100 W
Maximum vacuum	2.300 Pa
Dimensions (L x W x H)	210 x 460 x 660 mm 8.3 x 18.1 x 26 in.
Weight	15 kg / 33 lb.

Attributes

- Mobile fume extraction unit purifies air at up to two workstations
- Electronic filter control and easy filter exchange
- Wireless remote control with alarm function
- Noise-dampened metal housing
- Quick and simple installation
- Trolley available as accessory
- Minimized footprint
- Switching power supply fits all global voltages
- Optimized lifetime filter

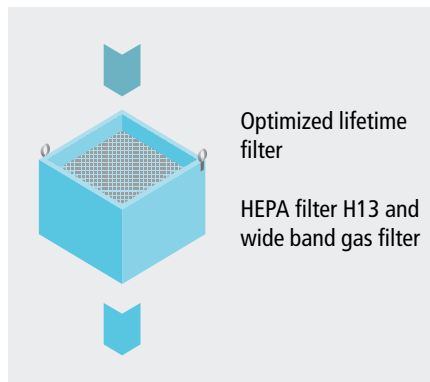

Optimized lifetime filter

HEPA filter H13 and wide band gas filter

WFE 2X includes:

- WFE 2X Fume Extraction Unit 100-240 V / 50/60 Hz
- Compact filter
Consists of: HEPA filter H13, wide band gas filter (50% active carbon / 50% Puratex)

See accessories for WFE 2X on page 16.

Order No. 230V	005 36 588 99
Order No. 120V	WFE2X

WFE 2X Kit 1



Portable fume extraction kit for one work station, flex arm

WFE 2X Kit 1 includes:

- 005 36 588 99 WFE 2X Fume Extraction Unit 100-240 V / 50/60 Hz
- 005 36 572 99 KIT 1 WF Angled 60 for volume extraction consists of:
005 36 578 99 Extraction arm
005 36 577 99 Angled nozzle
005 36 574 99 Stop valve
005 365 75 99 Bench mounting bracket
005 36 576 99 Extraction hose

Order No. 120V	WFE2XKIT1
----------------	-----------

WFE 2X Kit 1S



Portable fume extraction kit for one workstation, articulated arm

WFE 2X Kit 1S includes:

- 005 36 588 99 WFE 2X Fume extraction unit 100-240 V / 50/60 Hz
- 005 36 579 99 KIT 1 WF 60 Angled articulated extraction arm for volume extraction consists of:
005 36 598 99 Articulated extraction arm
005 36 573 99 Angled nozzle
005 365 75 99 Bench mounting bracket
005 36 576 99 Extraction hose
005 36 578 99 Extraction arm

Order No. 230V	005 36 587 99
Order No. 120V	WFE2XKIT1S

WFE 2S

Mobile fume extraction unit
available in two kits



ESD safe



low sound level

The fume extraction unit WFE 2S is easy to install and operate. It is designed as a smaller, central system and is supplied complete with flexible hose, arm, and bracket, ready for installation. A powerful, maintenance-free pump provides continuous fume extraction at a maximum air extraction rate of 230 m³/h. A built-in microprocessor controls the adjustable pump speed, avoiding unnecessary waste of suction power and saving energy. To optimize the degree of pollutant separation, the WFE 2S can be modified with filters for different applications.

Technical Data	
Maximum capacity	4 workstations
Maximum extraction rate	230 m ³ /h
Sound level	48 db (A) in 1 m distance
Standard connection	pipe system 50
Operating voltage	120/230 V / 50/60 Hz
Power input	275 VA
Maximum vacuum	2.700 Pa
Dimensions (L x W x H)	320 x 320 x 395 mm 12.6 x 12.6 x 15.5 in.
Weight	19 kg / 41.8 lb.

Attributes

- Two kits available
- Mobile fume extraction unit purifies air at up to four workstations
- Electronic filter control and easy filter exchange
- Four wheels allow easy movement of the unit
- Remote control with alarm function
- Noise-dampened metal housing
- Quick and simple installation

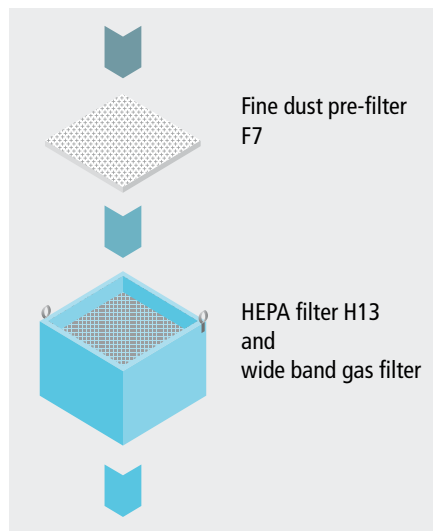

WFE 2S includes:

- WFE 2S Fume Extraction Unit 120/230 V / 50/60 Hz
- Compact filter
Consists of: HEPA filter H13, wide band gas filter (50% active carbon / 50% Puratex)
- Fine dust pre-filter F7

Order No. 230V 005 36 266 99

Order No. 120V WFE2S

Option: WFE 2S with gas filter

- Compact filter for adhesive fumes. Consists of: wide band gas filter (50% active carbon / 50% Puratex)

Order No. 230V 005 36 466 99

Order No. 120V WFE2SG

WFE 2 Kit 1



Portable fume extraction kit for one work station

WFE 2 Kit 1 includes:

- 005 36 266 99 WFE 2S Fume Extraction Unit 120/230 V / 50/60 Hz
- 005 36 572 99 KIT 1 WF Sloped 60 for volume extraction consists of:
005 36 578 99 Extraction arm
005 36 577 99 Angled nozzle
005 36 574 99 Stop valve
005 365 75 99 Bench mounting bracket
005 36 576 99 Extraction hose

Order No. 230V

005 36 436 89

Order No. 120V

WFE2SKIT1

WFE 2 Kit 2



Portable fume extraction kit for two work stations

WFE 2 Kit 2 includes:

- 005 36 266 99 WFE 2S Fume Extraction Unit 120/230 V / 50/60 Hz
- 2 x 005 36 572 99 KIT 1 WF Sloped 60 for volume extraction consists of:
2 x 005 36 578 99 Extraction arm
2 x 005 36 577 99 Angled nozzle
2 x 005 36 574 99 Stop valve
2 x 005 365 75 99 Bench mounting bracket
2 x 005 36 576 99 Extraction hose

Order No. 230V

005 36 456 89

Order No. 120V

WFE2SKIT2

Volume Extraction

WFE 2ES / WFE 2CS

An economical solution
to fume extraction



Portable fume extraction kit for one workstation

The Fume Extraction Unit WFE 2ES is easy to install and operate. It is designed as a smaller central system and is supplied complete with flexible hose, arm and bracket, ready for installation.



Technical Data	
Maximum capacity	2 workstations
Maximum extraction rate	220 m³/h
Sound level	55 db (A) at 1 m distance
Operating voltage	230V / 50Hz (115V / 60Hz)
Power input	115 VA
Maximum vacuum	1.800 Pa
Dimensions (L x W x H)	320 x 320 x 395 mm
	12.6 x 12.6 x 15.5 in.
Weight	9 kg / 19.8 lb.

WFE 2ES includes:

- 005 36 506 99 WFE 2ES Fume Extraction Unit
- Compact filter
Consists of: HEPA filter H12, active carbonate foam
- Fine dust pre-filter F 5
- 005 36 571 99 KIT 1 WF Funnel 60 for volume extraction consists of:
 - 005 36 578 99 Extraction arm
 - 005 36 573 99 Funnel nozzle
 - 005 36 574 99 Stop valve
 - 005 365 75 99 Bench mounting bracket
 - 005 36 576 99 Extraction hose

Order No. 230V 005 36 516 89

Order No. 120V WFE2ES KIT1

Option: Arm with sloped nozzle

- 005 36 572 99 KIT 1 WF Angled 60 for volume extraction consists of
 - 005 36 578 99 Extraction arm
 - 005 36 577 99 Angled nozzle
 - 005 36 574 99 Stop valve
 - 005 365 75 99 Bench mounting bracket
 - 005 36 576 99 Extraction hose

Option: WFE 2CS with speed control

Order No. 230V 005 36 526 99

Order No. 120V WFE2CS

Attributes

- Mobile fume extraction unit purifies air up to two workstations
- Easy filter exchange
- Quick and simple installation
- Optional speed control (WFE 2CS)



ESD safe



low sound level

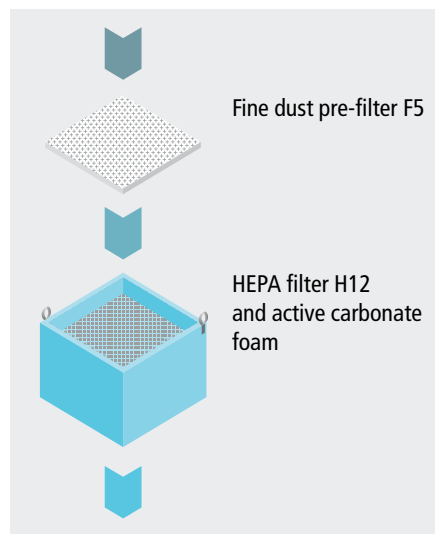

Installation Options

Installation option for a central system utilizing WFE 2S

Total pipe length: 15 m

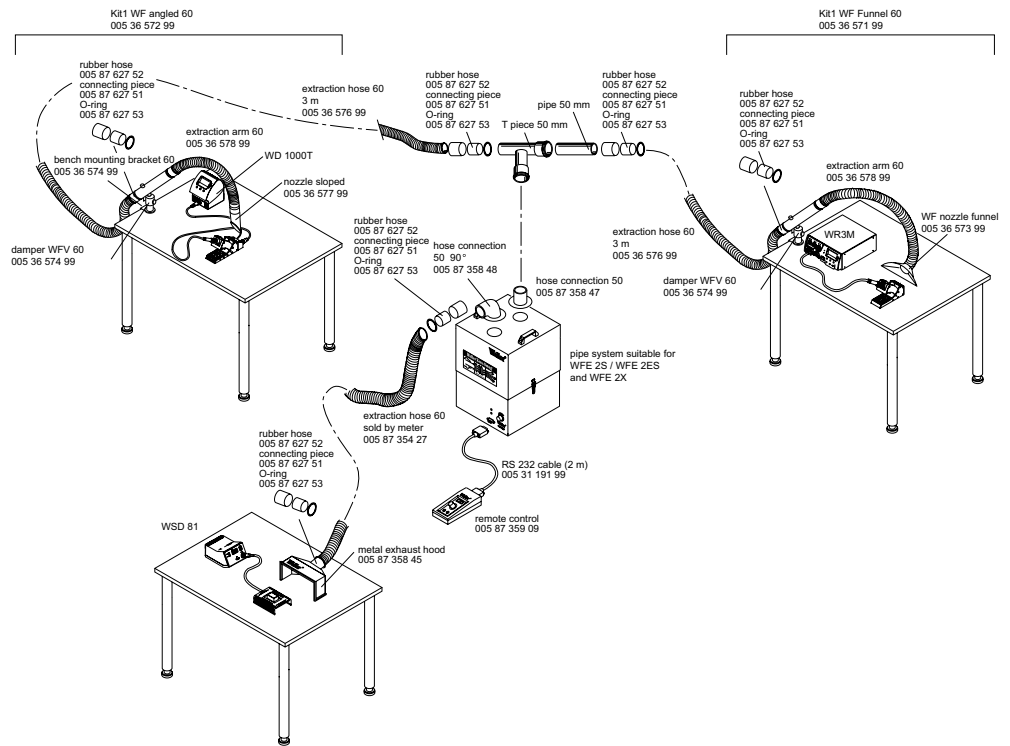

Installation option for a central and stand alone system utilizing WFE 4S

Total pipe length: 30 m

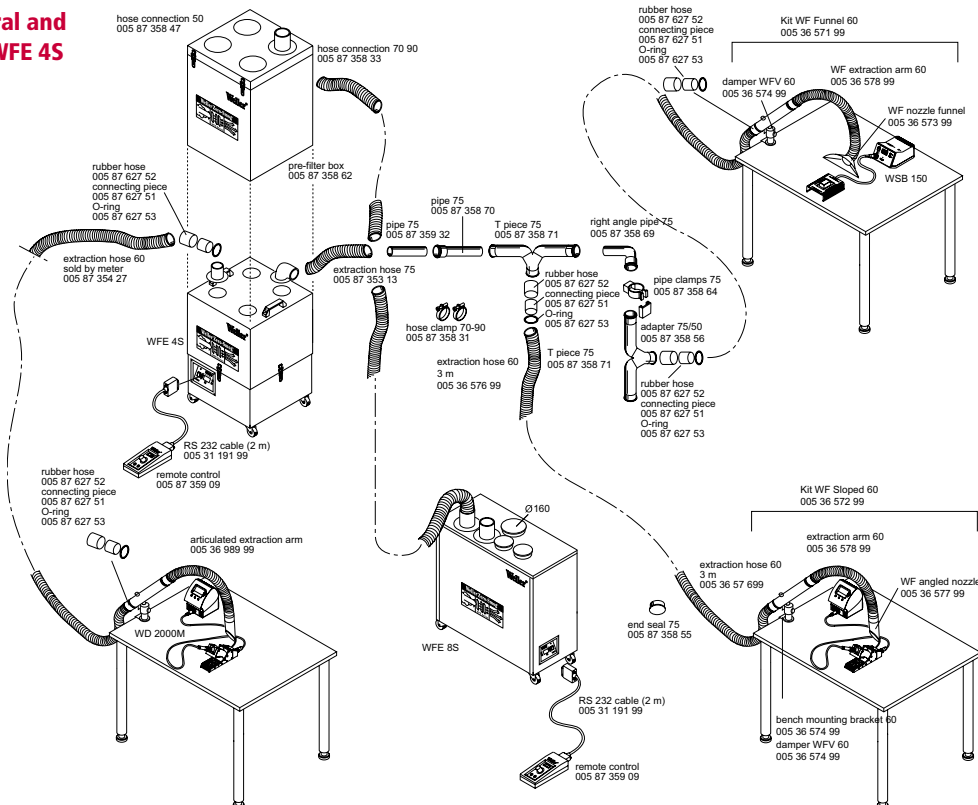

Volume Extraction

Accessories

When soldering, gluing, or working with solvents, it is important to place the nozzle as close to the source as possible to prevent harmful particles and gases being spread into the work area.

The Weller 60 mm (2.36 in.) flexible extraction arms allow quiet and efficient capture of polluted air. The arms and nozzles feature snap-fit connections, and are simple to install, easily locking into the desired position.



Order No.	Description
005 87 358 47	Hose connection 50 for WFE 2S and WFE 4S, e.g. for the direct connection of accessories by means of 50 mm (1.96 in.) extraction hose. Black plastic.
005 87 358 32	Hose connection 75 for WFE 2S and WFE 4S, e.g. for connection to a stand alone system by means of 75 mm (2.95 in.) pipe or 75 mm (2.95 in.) extraction hose. Black plastic.
005 87 358 48	Hose connection 50, 90° for WFE 2S and WFE 4S, e.g. for the direct connection of accessories by means of 50 mm (1.96 in.) extraction hose. Black plastic.
005 87 358 33	Hose connection 75, 90° for WFE 2S and WFE 4S, e.g. for connection to a stand alone system by means of 75 mm (2.95 in.) pipe or 75 mm (2.95 in.) extraction hose. Black plastic.
005 87 353 13	Extraction hose 75 , 75 mm (2.95 in.), for connection to pipe system 75. Sold by the meter. Flexible gray/black plastic.
005 36 576 99	Extraction hose 60 , 60 mm (2.36 in.), for connection to pipe system 50. 3 m (118.11 in.). Flexible gray/black plastic.
005 87 354 27	Extraction hose 60 , 60 mm (2.36 in.), for connection to pipe system 50. 1 m (39.37 in.). Flexible gray/black plastic.
005 87 358 79	Hose clamp 50 – 70 mm , (1.96 - 2.75 in.) set of two, for securing extraction hose 50.
005 87 358 31	Hose clamp 70 – 90 mm , (2.75 - 3.54 in.) set of two, for securing extraction hose 75.



Order No.	Description
005 36 598 99	Articulated extraction arm , 60 mm diameter, with two articulated joints and bench clamp. ESD safe.
005 36 578 99	Flexible extraction arm , 60 mm (2.36 in.) diameter, for angled and funnel nozzles. Maximum length 1 m (39.37 in.), ESD safe.
005 36 577 99	WF 60 angled nozzle for flexible and articulated extraction arm.
005 36 573 99	WF funnel nozzle 60 , for flexible and articulated extraction arm, 230 mm x 100 mm.
005 87 358 45	Exhaust hood , 200 x 100 mm (7.87 x 3.93 in.), recommended for use with hot air soldering operations; uses extraction hose 60.
005 36 380 99	WFDD 50 Extraction plate with 1 m (39.37 in.) flexible hose, 300 x 210 mm (11.81 x 8.26 in.), for adhesive and solvent fume extraction. ESD safe.

Volume Extraction

Accessories



Order No.	Description
005 36 574 99	WFV 60 Stop valve. Table connector for 60 mm (2.36 in.) flex arm and extraction tube including air flow valve.
005 36 575 99	Bench mounting clamps. Maximum width of clamp 100 mm (3.93 in.). 100 mm (3.93 in.) diameter. Metal.
005 87 627 53	Adapter with Silicone O-ring, 50 mm (1.96 in.) diameter. Seal for 60 mm (2.36 in.) flex arm mounted directly on WFE 2S and WFE 2ES.
005 87 627 50	60/50 Adapter for applications using the 60 mm (2.36 in.) extraction system connected to the former 50WFTB and WFFMP50.

Accessories for WFE 2X

Order No.	Description
005 36 591 99	Hanging device for table mounting for fume extraction unit WFE 2X.
005 36 592 99	Trolley for fume extraction unit WFE 2X.



Exhaust accessories to blow waste air out of a building

Order No.	Description
005 87 359 20	Exhaust adapter of pipe 100 to fume extraction unit WFE 20D.
005 87 358 40	Exhaust adapter of pipe 100 to fume extraction unit WFE 4S.
005 87 359 15	Exhaust adapter of pipe 75 for fume extraction unit WFE 2S.

Remote control for tip and volume extraction units



Order No.	Description
005 87 359 09	Remote control for fume extraction units WFE 20D, WFE 2S, WFE 4S and WFE 8S. Switching unit on/off, speed setting (only WFE 2S / WFE 4S), filter status display.
005 31 191 99	Interface cable RS 232 , 2 m (78.74 in.) for remote monitoring by PC (type 1:1).
005 36 593 99	Remote control for fume extraction unit WFE 2X with 2 m (78.74 in.) cable.

Replacement Filters

Order No.	Filters for WFE 8S:
005 36 594 99	Replacement pre-filter
005 36 595 99	Replacement compact filter Consists of: HEPA filter H13, wide band gas filter (50 % active carbon, 50 % Puratex)

Order No.	Filter for WFE 2X:
005 36 590 99	Replacement compact filter Consists of: HEPA filter H13, wide band gas filter (50 % active carbon, 50 % Puratex)

Order No.	Filters for WFE 4S:
005 87 358 37	Fine dust filter F5 (10 pieces)
005 87 358 36	Fine dust filter F7 (10 pieces)
005 87 358 38	Compact filter Consists of: HEPA filter H13, wide band gas filter (50 % active carbon, 50 % Puratex)
005 87 358 35	Option: Adhesive fume filter (50 % active carbon, 50 % Puratex)

Order No.	Filters for WFE 2S:
005 87 358 84	Fine dust filter F5 (10 pieces)
005 87 358 85	Fine dust filter F7 (10 pieces)
005 87 358 83	Compact filter Consists of: HEPA filter H13, wide band gas filter (50 % active carbon, 50 % Puratex)
005 87 358 95	Option: Adhesive fume filter (50 % active carbon, 50 % Puratex)

Order No.	Filter for WFE 2ES:
005 87 627 01	Fine dust filter F5 (10 pieces) Compact filter Consists of: HEPA filter H12, wide band gas filter (10 % active carbonate foam)

Order No.	Filters for Pre-filter Box:
005 87 358 60	Filtering ash F7 for large quantities of dust
005 87 359 24	Filtering fine dust for sticky of arrears (e.g. large quantities of liquid flux)

Tip Extraction



Tip Extraction

Weller® FE (Fume Extraction) soldering irons have a smoke tube integrated into to the handle. When soldering, the tube is positioned directly above the joint and collects any fumes produced. Fume extraction irons can be connected to Weller Zero-Smog Systems WFE, WFE P (both bench mounted units driving up to two irons) or WFE 20D – a mobile unit driving up to 40 irons.

A safety rest with Stop + Go function switches the extraction system on when the FE soldering iron is removed from the safety rest and off after a short delay when the iron is replaced (WFE and WFE P only). Fume extraction attachments can be retro-fitted to non-fume extraction Weller soldering irons.

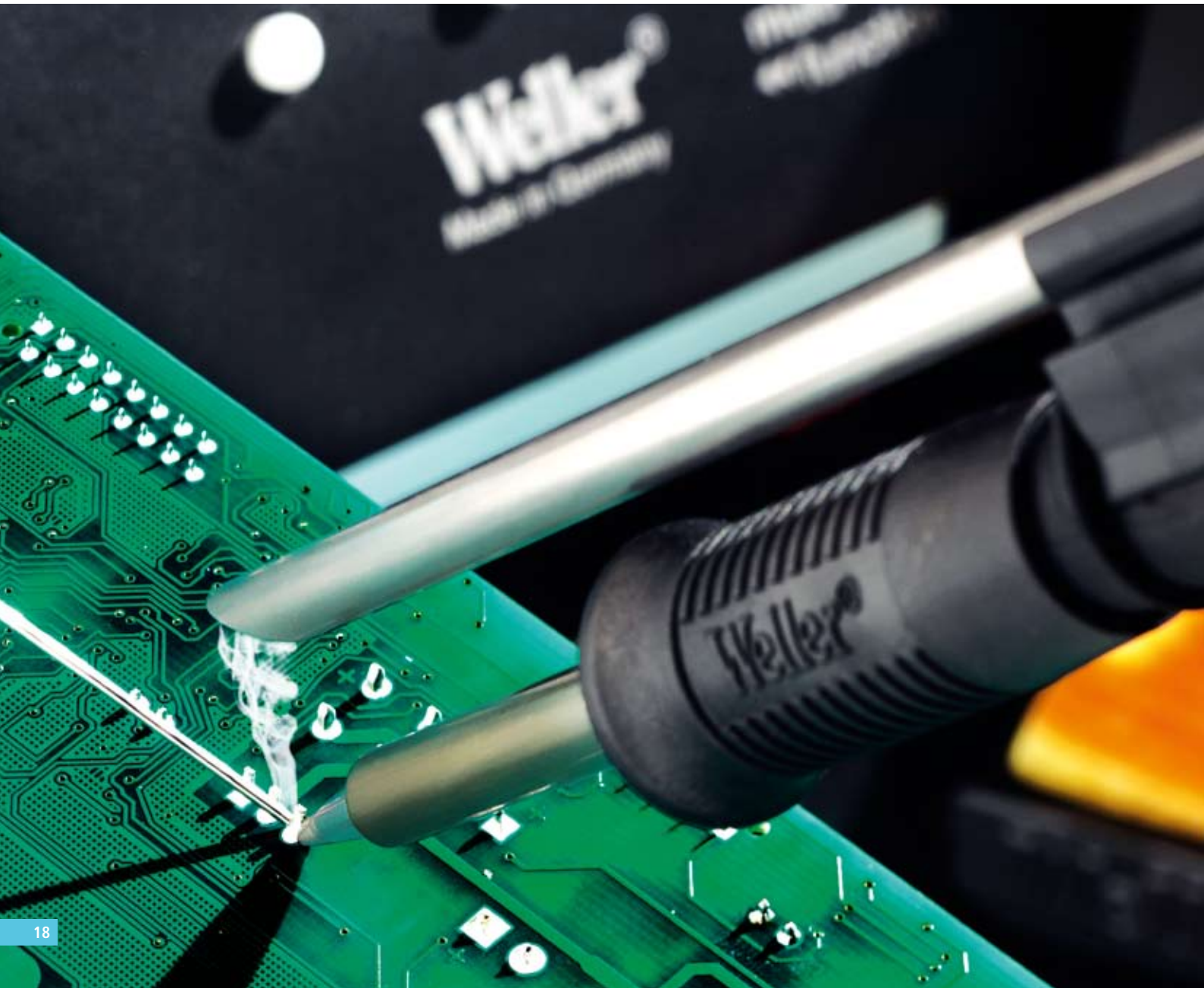

Tip Extraction Units

Characteristics

- FE (Fume Extraction) soldering irons extract fumes directly at the soldering tip.
- Less airflow and high vacuum, up to 12,000 Pa for efficient fume extraction.
- Maximum bridging distance 200 m, WFE 20D requires Weller pipe system 50.
- Filter condition warning – LED on the unit or remote control via RS 232 and PC (WFE 20D).
- Variable electronically controlled pump speed, adjustable at the unit or by remote control via RS 232 and PC (WFE 20D).

Areas of application

- Hand soldering
- Small solder baths



- WFE 20D
up to 20 workstations



- WFE P
up to two workstations



- WFE
up to two workstations

Tip Extraction



WFE

Small, portable, compressed air driven fume extraction unit



ESD safe



low sound level

The fume extraction unit WFE requires clean and oil-free compressed air. The vacuum is generated by a maintenance-free compressed air converter. The contaminated air is purified by a pre-filter and main filter system. A compressed air cleaning filter removes additional odors caused by the compressed air. This highly efficient filter system makes the WFE a genuine air recovery system. The filter-lift system allows fast and convenient filter cartridge replacement. The FE (Fume Extraction) soldering irons are connected directly to the unit – additional leads are not required.

Technical Data

Maximum capacity	2 FE soldering irons
Sound level	< 39 db (A) at 1 m distance
Maximum vacuum	20,000 Pa
Operating pressure	3.5 - 6 bar
Air consumption	30 l/min.
Height	200 mm (7.8 in.)
Diameter	140 mm (5.5 in.)
Weight	2.7 kg / 5.9 lb.

WFE includes:

- WFE Fume Extraction Unit
- Compressed air cleaning filter
- Compact filter
Consists of: HEPA filter H13, wide band gas filter (50% active carbon, 50% Puratex)
- Fine dust filter F7

Order No. 230V 005 36 402 99

Attributes

- Up to two FE soldering irons can be connected
- Maintenance-free compressed air converter
- Portable unit for stand-alone applications

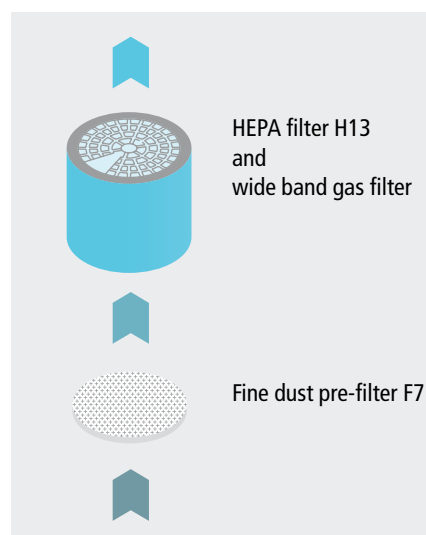

WFE P

Small, portable, electrically driven fume extraction unit



ESD safe



low sound level

The Weller® WFE P is a line voltage fume extraction unit designed to run with one or two FE (Fume Extraction) soldering irons. The WFE P has an electric, long-life, soundproofed vacuum pump to produce the required vacuum – it does not need a compressed air supply. The vacuum pump has two power settings which can be selected by means of rocker switches, depending on the number of FE soldering irons connected to the unit. This saves energy. The motor is maintenance-free and has a thermal overload to protect the unit. The filter-lift system allows fast and convenient main filter replacement. FE soldering irons are connected directly to unit – additional leads are not required.

Technical Data

Maximum capacity	2 FE soldering irons
Sound level	< 45 db (A) at 1 m distance
Operating voltage	230 V / 50 Hz
Power input	70 W
Maximum vacuum	30,000 Pa
Height	295 mm (11.6 in.)
Diameter	140 mm (5.5 in.)
Weight	4 kg / 8.8 lb

WFE P includes:

- WFE P Fume Extraction Unit
- Compact filter
Consists of: HEPA filter H13, wide band gas filter (50% active carbon, 50% Puratex)
- Fine dust filter F7

Order No. 230V 005 36 386 99

Order No. 120V 005 36 232 99

Attributes

- Up to two FE soldering irons can be connected
- Electric vacuum pump to produce the required vacuum
- Two power stages for higher extraction performance with two FE soldering irons
- Portable unit for stand-alone applications

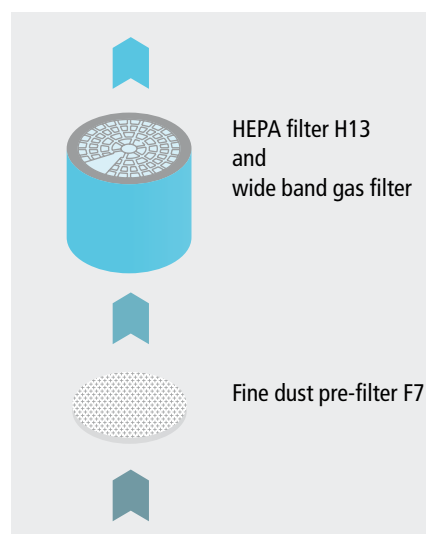

WFE 20D

Mobile, powerful, electronically driven fume extraction unit



ESD safe



low sound level

Up to five Weller® FE (Fume Extraction) soldering irons can be connected directly to the fume extraction unit WFE 20D. Using the Pipe System 50 (available as an accessory) up to 40 FE soldering irons can be supported by the unit. The powerful maintenance-free turbine generates a vacuum of 12,000 Pa and is electronically

controlled. Operating hours and filter contamination level are also recorded electronically. The filter system achieves a filtration rate of 99.95% as per EN 1822 with a particle size of 0.12 µm.

Characteristics

- Two operating modes:
Mode 0: Vacuum regulated to 12,000 Pa
Mode 1: Extraction performance can be set from 20% to 100% with the control buttons.
- Electronic filter check (LED) through differential pressure measurement. If the specified degree of contamination is exceeded, the unit switches off.
- Electronic filter operation status display. For better management of filter change intervals – the filter operating hours can be pre-specified. The need for filter change is indicated in advance, allowing adequate time for filter procurement and replacement. Interface RS 232 for remote monitoring or remote control.
- Remote control available as an accessory.

Attributes

- Up to 40 FE soldering irons can be connected
- Electrically driven, maintenance free turbine produces the required vacuum
- Four wheels allow easy movement of the unit
- Mobile unit for central and stand alone applications
- Central installation for pipe systems up to 200 m

Technical Data	
Maximum capacity	40 FE soldering irons
Sound level	< 51 db (A) at 1 m distance
Operating voltage	230 V / 50 Hz 120 V / 60 Hz
Power input	630 VA
Maximum vacuum	12.000 Pa
Max. delivery rate	100 m³/h
Dimension (L x W x H)	450 x 450 x 695 mm 17.7 x 17.7 x 27.3 in
Weight	45 kg / 99 lb.

WFE 20D includes:

- WFE 20D Fume Extraction Unit
- Compact filter
Consists of: HEPA filter H13, wide band gas filter (50% active carbon, 50% Puratex)
- Fine dust filter F7

Order No. 230V 005 36 476 99

Order No. 120V WFE20D

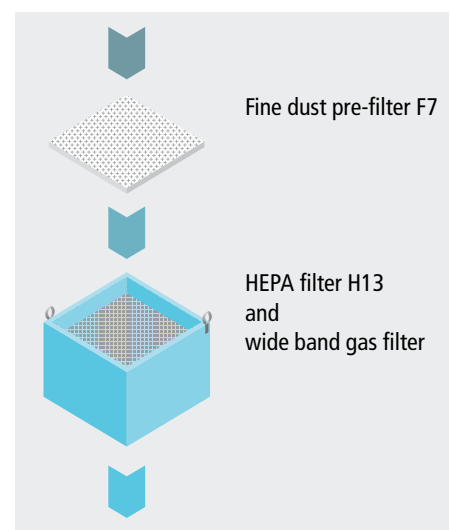

Tip Extraction



FE (Fume Extraction) Soldering Irons



Weller® FE soldering irons feature a smoke absorption tube integrated into the handle. It can be placed over the joint when soldering, but can be retracted when access to the joint is a problem. It can also be removed for cleaning. The irons are temperature controlled, ergonomic, and allow precise handling. These

electronically-controlled irons can be driven from any Weller power unit compatible with the rating of the iron or any Weller rework station. The range of iron power ratings and the extensive range of solder tips mean that there is an iron to suit all applications. FE soldering irons are supplied with a burn proof hose 5 mm (0.19 in.) diameter, 2.5 m (98.42 in.) long.



ESD safe



Order No.	Description
005 33 150 99	FE 50 Soldering Iron Set 50 W / 24 V, with safety rest KH 20*. (Not available in North America.)
005 32 152 99	FE 50M Soldering Iron Set 50 W / 24 V, Magnastat controlled with safety rest KH 20*. (Not available in North America.)
005 33 151 99	FE 75 Soldering Iron Set 80 W / 24 V with safety rest KH 20*. For use with LT tips.
005 26 162 99	FE 80 Soldering Iron 80 W / 24 V with safety rest KH 20*. (Not available in North America.)

* Cleaning brush for FE tubes and fume extraction funnels included with soldering irons for use with KH 20 and KH 23 safety rests.

FE Attachments

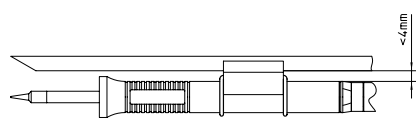

A range of FE attachments are available to fit standard Weller soldering and desoldering irons to convert them to fume extraction versions. The attachments are supplied with all necessary fittings and hoses. The performance of the retro-fitted tools is not affected.

For Weller soldering irons WP 120, WP 80, WSP 80, WMP, MLR 21 or soldering irons with handle diameter 10 – 13 mm (0.39 – 0.51 in.), clip is attached to the soldering iron with a silicone O-ring.

Order No.	Description
005 29 186 99	FE Attachment with tube, 6 mm (0.23 in.) for WP 120, WSP 80, WP 80, MLR 21, MLR 80, WMP.
005 29 185 99	FE Attachment with tube, 4.5 mm (0.17 in.) for WP 120, WMRP and WSP 80, WP 80, MLR 21, MLR 80, WMP for fine soldering applications.
005 87 448 75	FE Spare Clip-Set for FE attachment, tube 4.5 mm (0.17 in.).
005 87 448 76	FE Spare Clip-Set for FE attachment, tube 6.0 mm (0.23 in.).
005 15 156 99	WDH 50 safety rest for soldering iron with FE attachment.
005 25 125 99	FE Attachment for LR 21, LR 82, TCPS, W 61, W 101, WSP 150 with safety rest AK 1.
005 28 126 99	FE Attachment for WSF 80D5/8.
005 13 125 99	FE Attachment for DS 22, DS 80 and DSX 80 desoldering irons.

Accessories for FE Irons



Order No.	Description
005 36 352 99	Locking clip. The locking clip is used to disconnect FE (Fume Extraction) soldering irons that are not required so that there is no unnecessary loss of extraction power. The clip can be operated quickly and easily.
005 25 410 00	Extraction hose (spare part) Heat-resistant silicone hose, 5 mm (0.19 in.), for all FE (Fume Extraction) soldering irons (sold by the meter).

Order No.	Description
	Cord support. The cord support keeps the soldering iron cord out of the direct working area. This allows easier handling of the soldering iron.
005 15 065 99	Cord support for safety rest AK 20.
005 15 066 99	Cord support for safety rest KH 20/23.

Safety Rests for FE Soldering Irons



Order No.	Description
005 15 030 99	AK 20 Safety rest for FE 50, FE 50M, FE 75, FE 80; for LR 21, LR 82 and TCP with attachment.
005 15 020 99	KH 20 Safety rest for FE 50, FE 50M, FE 75, FE 80.
005 15 023 99	KH 23 Safety rest for FE 25.
005 15 140 99	WPH 80 Safety rest for WSP 80FE; for MLR 21 with FE attachment.

Tip Extraction



Safety Rests with Stop + Go Function for FE soldering irons together with fume extraction units WFE and WFE P

The Weller Stop + Go safety rests are recommended accessories for FE soldering irons using the WFE or WFE P extraction units. A fiber-optic sensor switches the extraction unit on when the FE soldering iron is removed from the

safety rest and off when the FE soldering iron is replaced in the safety rest. After a short delay to gather the fumes from any solder on the tip, it switches the unit off. This saves the soldering tip and reduces running costs.



Order No.	Description
005 15 086 99	KHP Pneumatic basic unit (for WFE), safety rest with Stop + Go function with fiber-optic sensor for soldering irons FE 25, FE 50, FE 50M, FE 75 and FE 80.
005 15 076 99	KHE Electric basic unit (for WFE P), safety rest with Stop + Go function with fiber-optic sensor for soldering irons FE 25, FE 50, FE 50M, FE 75 and FE 80.
005 15 080 99	KHE/P Second safety rest with fiber-optic sensor for extending to 2 workplaces for soldering irons FE 25, FE 50, FE 50M, FE 75 and FE 80.
005 15 084 99	KHP 80 Basic unit pneumatic (for WFE) safety rest with Stop + Go function with fiber-optic sensor for soldering iron WSP 80FE.
005 15 083 99	KHE 80 Basic unit electric (for WFE P) safety rest with Stop + Go function with fiber-optic sensor for WSP 80FE.
005 15 141 99	KHE 80/P 80 Second safety rest with fiber-optic sensor for extending to two workstations for WSP 80 FE.

Items on this page not available in North America.

Accessories for workbench installations



Order No.	Description
005 36 316 99	Extraction hose 40 , 1 m (39.37 in.), 40 mm (1.5 in.). Complete with 2 connecting elements for direct connection of unit (WFE 20D) to pipe system 50. Flexible grey/black plastic.
005 36 414 00	Extraction hose 40 , 40 mm (1.5 in.) without connecting elements. Sold by the meter. Flexible grey/black plastic.
005 36 415 99	Connecting element 40 – 50 for connecting extraction hose 40 and pipe system 50. Black rubber.
005 36 326 99	Extension hose DN 17 (13 x 3 mm), 5 m, 17 mm (0.6 in.), used where the fume extraction iron is further than 2.5 m (98.42 in.) from the pipe system 50. Note: Connection nipple for hose 17 and adapter 17 will be required. Clear plastic.
005 87 358 65	Connection nipple for extension hose 17.
005 87 358 66	Nut G 3/8" for connection nipple.
005 36 343 99	Adapter 17 for connection extension hose DN 17 with 5 mm (0.19 in.) extension hose on FE irons.
005 36 338 99	Connection nipple for 5 mm (0.19 in.) diameter extraction hose to connect FE soldering irons directly to pipe system 50. The connection nipple may be screwed into the pipe system at any point.
005 87 350 50	End cap to close off connection nipple (not shown).

Replacement Filters

Order No.	Filters for WFE:
005 87 357 57	Compressed air - cleaning filter
005 36 410 99	Compact filter Consists of: HEPA filter H13, wide band gas filter (50% active carbon, 50% Puratex)
005 36 407 99	Compact filter Consists of: HEPA filter H13, wide band gas filter (100% active carbon)
005 36 421 99	Fine dust filter F7 (3 pieces)
005 36 597 99	Compact filter with enlarged pre-filter

Order No.	Filters for WFE 20D:
005 87 358 37	Fine dust filter F5
005 87 358 36	Fine dust filter F7
005 87 358 38	Compact filter Consists of: HEPA filter H13, wide band gas filter (50% active carbon, 50% Puratex)

Order No.	Filters for WFE P:
005 36 410 99	Compact filter Consists of: HEPA filter H13, wide band gas filter (50% active carbon, 50% Puratex)
005 36 407 99	Compact filter Consists of: HEPA filter H13, wide band gas filter (100% active carbon)
005 36 421 99	Fine dust filter F7 (3 pieces)
005 36 597 99	Compact filter with enlarged pre-filter

Tip Extraction



Installation Options

Installation option for a central system with WFE P

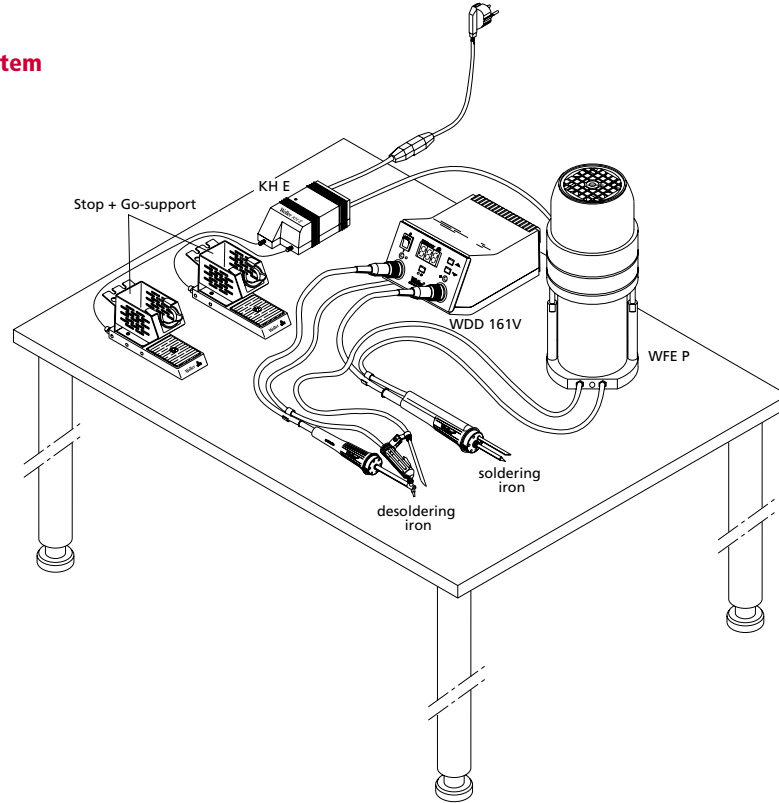

Installation option for a central and stand alone system with WFE 20D

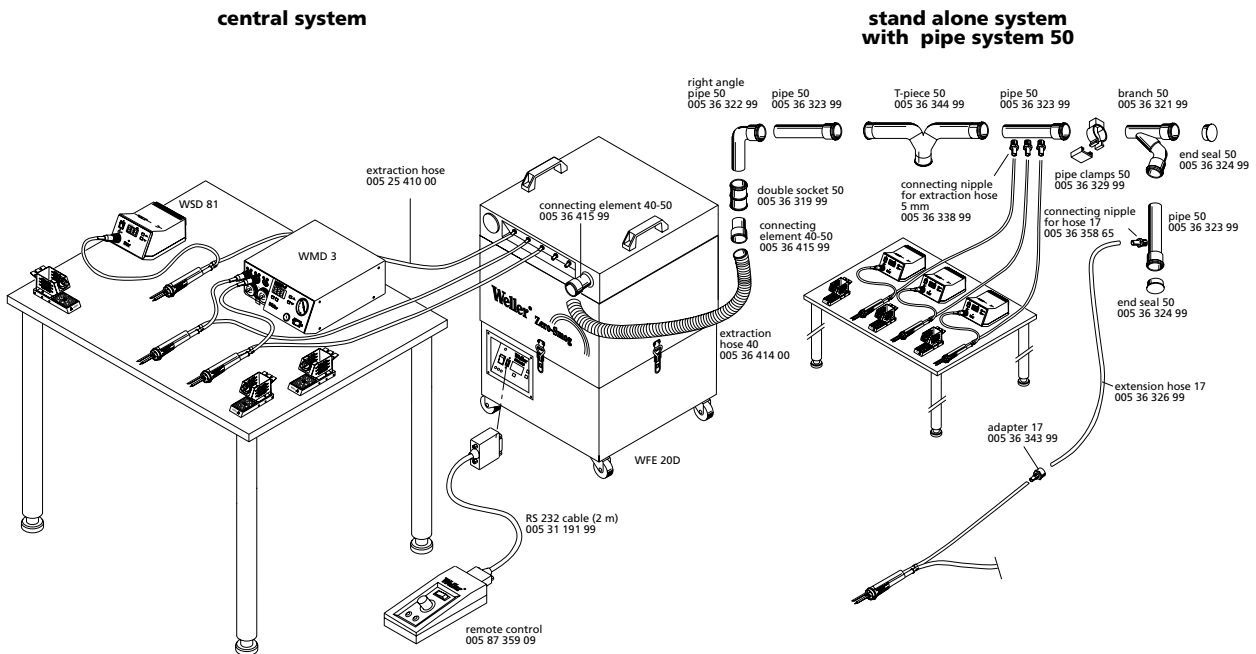

Pipe Systems for Tip and Volume Extraction

Pipe System 50 Tip Extraction

Tip extraction systems demand a high quality, constant level of vacuum across the installation. To achieve this it is necessary to use a pipe system with a relatively small diameter. The Weller pipe system 50 allows extraction **installations of up to 200 m** when used with the WFE 20D unit in a stand-alone system. The pipe sections are designed to join together and have internal seals. In a central system, the FE soldering irons are connected directly to the fume extraction units.



Pipe System 75 Volume Extraction

Volume extraction systems require a large volume of air to be extracted and the level of vacuum is of lesser importance. This means that a relatively large diameter pipe system is required. If the pipe diameter is too small the flow resistance is increased and extraction capacity reduced. The pipe system 75 allows **installations up to 30 m** with the WFE 4S used in a stand alone system. The pipe sections are designed to join together and have internal seals.

Order No. Pipe System 50	Pipe System 75	Description
005 36 323 99	005 87 358 70	Pipe , 2 m (78.74 in), with seal at one end. Black PEHD*.
005 36 322 99	005 87 358 69	Right angle pipe , 90°, 0.2 m (7.87 in), with seal at one end. Black PEHD*.
005 36 344 99	005 87 358 71	T-piece , 2 x 90°, 0.5 m (19.68 in), with 3 seals. Black PEHD*.
005 36 321 99		Branch , 2 x 45°, 0.3 m (11.81 in), with 2 seals. Black PEHD*.
005 36 319 99		Double socket . Black PEHD*.
005 36 324 99	005 87 358 55	End seal . Clear plastic.
005 36 329 99	005 87 358 64	Pipe clamps for pipes, (for securing to wall). Gray plastic.
	005 87 358 63	Adapter pipe system 75 to pipe system 50 with seals.
	005 87 358 56	Adapter PEHD* pipe system 75 to pipe system 50, without seals.

*PEHD = Polyethylene High Density

GERMANY

Cooper Tools GmbH
Carl-Benz-Straße 2
74354 Besigheim
Tel: (07143) 580-0
Fax: (07143) 580-108

USA

Cooper Tools
World Headquarters
1000 Lufkin Road
Apex, NC 27539 USA
Tel: (919) 387 0099
Fax: (919) 387 2614

FRANCE

Cooper Tools S.A.S.
25 Rue Maurice Chevalier BP 46
77832 Ozoir-la-Ferrière Cedex
Tel: (01) 60.18.55.40
Fax: (01) 64.40.33.05

ITALY

Cooper Italia S.r.l.
Viale Europa 80
20090 Cusago (MI)
Tel: (02) 9033101
Fax: (02) 90394231

SWITZERLAND

Erem S.A.
Rue de la Roselière 8
1400 Yverdon-les-Bains
Tel: (024) 426 12 06
Fax: (024) 425 09 77

GREAT BRITAIN

Cooper Tools
A Division of Cooper (GB) Ltd.
4th Floor Pennine House
Washington, Tyne & Wear
NE37 1LY
Tel: (0191) 419 7700
Fax: (0191) 417 9421

CANADA

Cooper Tools
5925 McLaughlin Road
Mississauga, Ontario
Canada L5R 1B8
Tel: (905) 501 4785
Fax: (905) 501 4786

CHINA

Cooper Hand Tools
18th Floor, Yu An Building
738 Dongfang Road
Pudong, Shanghai
200122 China
Tel: (21) 5111 8300
Fax: (21) 5111 8446

AUSTRALIA

Cooper Tools Pty. Limited
P.O. Box 366
519 Nurigong Street
Albury, N.S.W. 2640
Australia
Tel: (2) 6058-0300
Fax: (2) 6021-7403